

■  
FLEXIBLE GLASS DOORS





## We Design and Produce Business Solutions

At INTERMETAL S.A. we have the ability and capacity to undertake the most demanding projects made of glass and steel.

Our twenty seven years depth expertise and dedication in the design, manufacture and trade of glass systems and accessories, allowed us to develop a knowledge that is highly respected in our sector.

The challenges of modern glass constructions, give us the motivation to constantly improve our products and services beyond our customers' expectations.

The customer orientation and our philosophy ensure our clients' satisfaction, providing superior quality products, on time.

## index

### PARKING GLASS DOORS

04	SYSTEM PR-200
06	SYSTEM PR-200/R76
08	SYSTEM PR-150
10	SYSTEM PR-125
12	SYSTEM PR-100
14	SYSTEM PR-86/R76
16	SYSTEM FRP-75
18	SYSTEM FRP-75/R76
20	SYSTEM FRP-75/R60

### FOLDING GLASS DOORS

22	SYSTEM FN-200
24	SYSTEM FN-150
26	SYSTEM FN-100
28	SYSTEM FN-M200
30	SYSTEM PANORAMA

# PR-200

## flexible glass door with heavy duty rail

### PARKING SYSTEM



INAL® Frameless Movable Glass System, parking-type, with heavy duty certified aluminum rail 70 mm x 80 mm with **embedded stainless steel rod & certified stainless steel rollers**. Unlimited design possibilities for parking areas (vertical, diagonal or parallel parkings). Ability to create swing door panel with overhead concealed door closer in intermediate sections of openings (PR200/ SOC). Weather proofing along the entire length of the panel (PR-F200). Locking with Stainless steel front or side bolts or locking with double locking lock mechanism.

Available in Do It Yourself (DIY) or Made to measure upon request.

## technical specifications

Glass Type	Tempered or Laminated
Glass thickness	10-12mm
Panel weight	max 120kg
Maximum panel width	1,00m
Maximum opening height	3,50m
Type of PR-200 System	PR-F200 (Front Locking)
	PR-S200 (Side Locking)
Finishing	Natural anodized, Satin anodized, RAL powder coating
Without floor guide, No glass cuttings required	

### PANEL STORAGE/PARKING APPLICATIONS

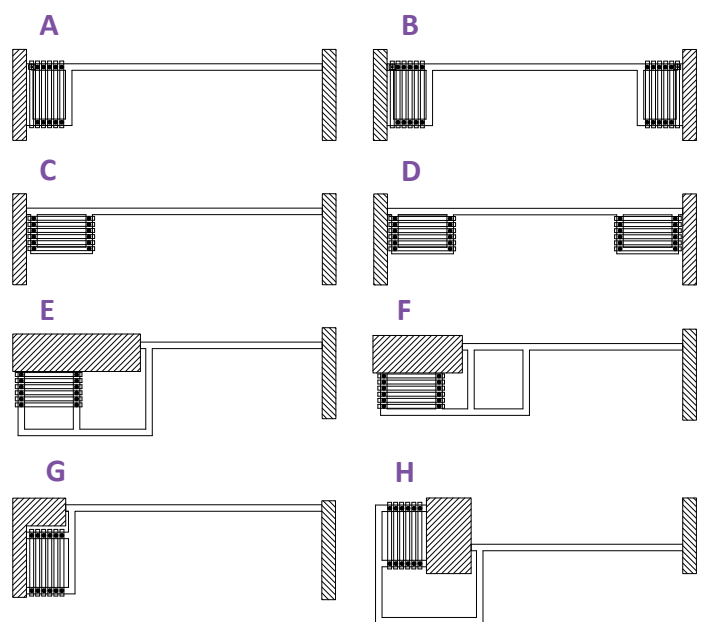

MULTIPLE CHOICES DEPENDING ON YOUR NEEDS

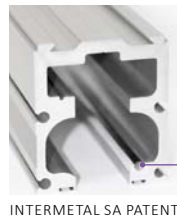
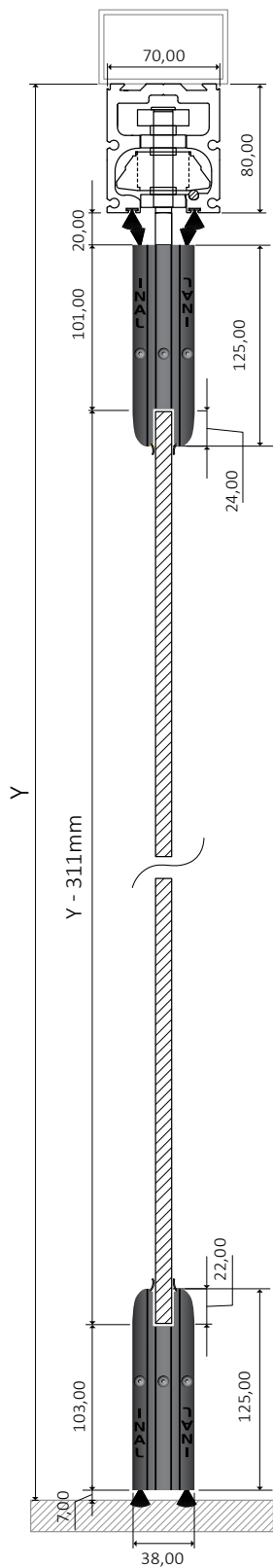

Heavy duty aluminum rail 70x80 with embedded stainless steel rod  
**STRENGTH TEST:** 3.450kg (165/049.01-1 N.T.U.A.).

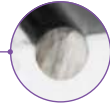

INTERMETAL SA PATENT



Stainless steel roller PR200 with clamp support.  
**STRENGTH TEST:** 4.600kg (165/049.01-2 N.T.U.A.).



**Parking Area**  
Big variety of parking areas for the storage of the panels



**PR200/SOC Panel**  
Swing- Sliding door panel with overhead concealed door closer in intermediate sections of openings (PR200/ SOC).



**NO FLOOR GUIDE REQUIRED**  
**NO GLASS CUTTINGS REQUIRED**

## locking options

### FRONT LOCKING



Lock Mechanism with Eurocylinder Key



Lock Mechanism with Half Cylinder and knob



Stainless Bolt



Side Cap with Stainless Bolt



Female Side Cap PR-S200

#### GLASS (TEMPERED) DIMENSION CALCULATION

Glass height (mm) =  $Y - 311$ mm, (Y = from the bottom of the steel beam)

Opening width (mm) = O.W.      Number of panels (pcs) = P.N.

Glass width (mm) =  $\{O.W. - [(P.N. \times 3mm) + 25mm]\} / P.N.$

#### GLASS (LAMINATED) DIMENSION CALCULATION

Glass height (mm) =  $Y - 304$ mm, (Y = from the bottom of the steel beam)

Opening width (mm) = O.W.      Number of panels (pcs) = P.N.

Glass width (mm) =  $\{O.W. - [(P.N. \times 3mm) + 25mm]\} / P.N.$

# PR-200/R76

## flexible glass door with heavy duty rail

### PARKING SYSTEM



INAL® Frameless Movable Glass System, parking-type, with heavy duty certified aluminum rail 55mm x 76mm with **embedded stainless steel rod & certified stainless steel rollers**. PR-200/R76 System is the proposition for easily self guided storage of the flexible glass panels. Ability to create swing door panel with overhead concealed door closer in intermediate sections of openings (PR200/R76SOC). Weather proofing along the entire length of the panel. Locking with Stainless steel front or side bolts or locking with double locking lock mechanism.

Available in Do It Yourself (DIY) or Made to measure upon request.

## technical specifications

Glass Type	Tempered or Laminated
Glass thickness	10-12mm
Panel weight	max 120kg
Maximum panel width	1,00m
Maximum opening height	3,50m
Type of PR-200/R76 System	PR-F200/R76 (Front Locking) PR-S200/R76 (Side Locking)
Finishing	Natural anodized, Satin anodized, RAL powder coating
Without floor guide, No glass cuttings required	

### PANEL STORAGE/PARKING AREA

EASILY SELF GUIDED STORAGE OF THE FLEXIBLE GLASS PANELS

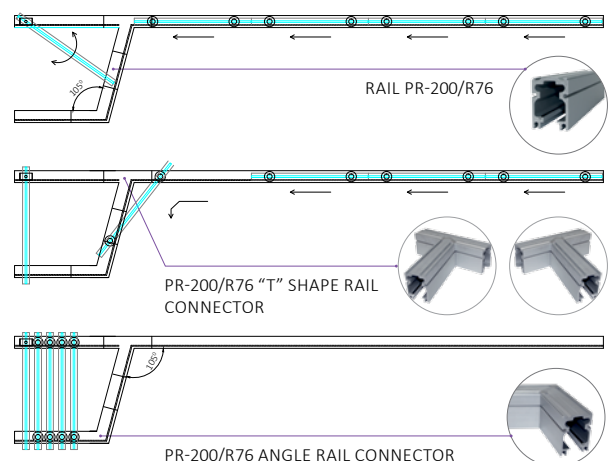

### PARKING APPLICATIONS

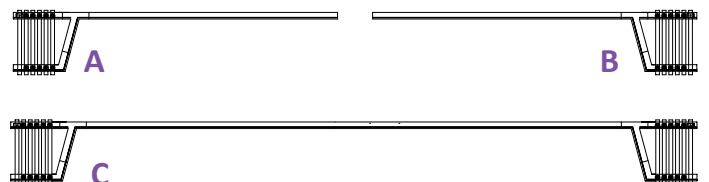

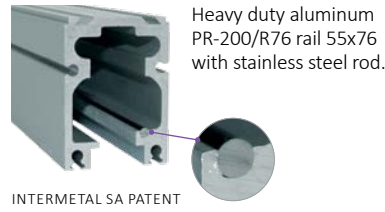
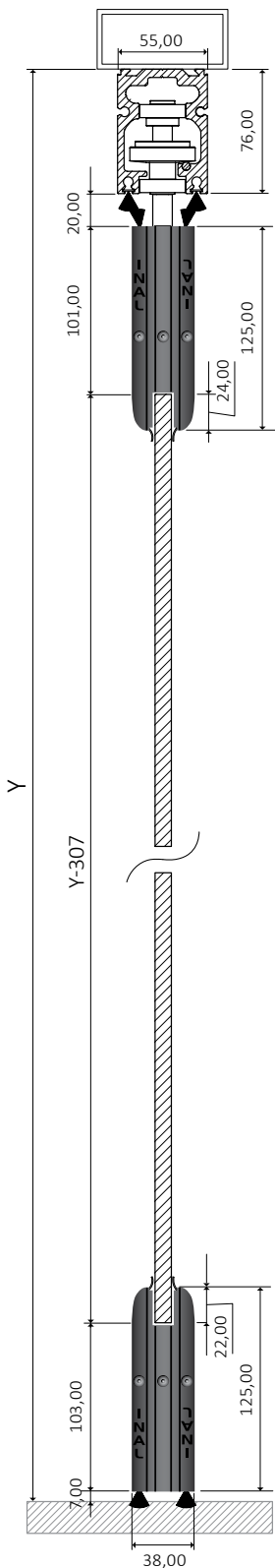

Stainless steel roller for diversion movement, with clamp support.



Stainless steel roller for straight movement, with clamp support.



**Parking Area**  
Easily self guided storage of the flexible glass panels.



**PR200/R76SOC Panel**  
Swing- Sliding door panel with overhead concealed door closer in intermediate sections of openings (PR200/R76SOC).



**NO FLOOR GUIDE REQUIRED**

**NO GLASS CUTTINGS REQUIRED**

## locking options

### FRONT LOCKING



Lock Mechanism with Eurocylinder Key



Lock Mechanism with Half Cylinder and knob



Stainless Bolt

### SIDE LOCKING



Side Cap with Stainless Bolt



Female Side Cap PR-S200

#### GLASS (TEMPERED) DIMENSION CALCULATION

Glass height (mm) =  $Y - 307\text{mm}$ , ( Y = from the bottom of the steel beam)

Opening width (mm) = O.W.      Number of panels (pcs) = P.N.

Glass width (mm) =  $\{O.W. - [(P.N. \times 3\text{mm}) + 25\text{mm}]\} / P.N.$

#### GLASS (LAMINATED) DIMENSION CALCULATION

Glass height (mm) =  $Y - 300\text{mm}$ , ( Y = from the bottom of the steel beam)

Opening width (mm) = O.W.      Number of panels (pcs) = P.N.

Glass width (mm) =  $\{O.W. - [(P.N. \times 3\text{mm}) + 25\text{mm}]\} / P.N.$

# PR-150

## flexible glass door with parking

### PARKING SYSTEM



INAL® Frameless Movable Glass System, parking-type, with middle size aluminum rail, 52 mm x 59 mm with **embedded stainless steel rod & stainless steel rollers**. Unlimited design possibilities for parking areas (vertical, diagonal or parallel parkings). Ability to create swing door panel with overhead concealed door closer in intermediate sections of openings (PR150/ SOC). Weather proofing along the entire length of the panel (PR-F150). Locking with Stainless steel front or side bolts or locking with double locking lock mechanism.

Available in Do It Yourself (DIY) or Made to measure upon request.

## technical specifications

Glass Type	Tempered or Laminated
Glass thickness	10mm
Panel weight	max 85kg
Maximum panel width	1,00m
Maximum opening height	2,80m
Type of PR-150 System	PR-F150 (Front Locking) PR-S150 (Side Locking)
Finishing	Natural anodized, Satin anodized, RAL powder coating
Without floor guide, No glass cuttings required	

### PANEL STORAGE/PARKING APPLICATIONS

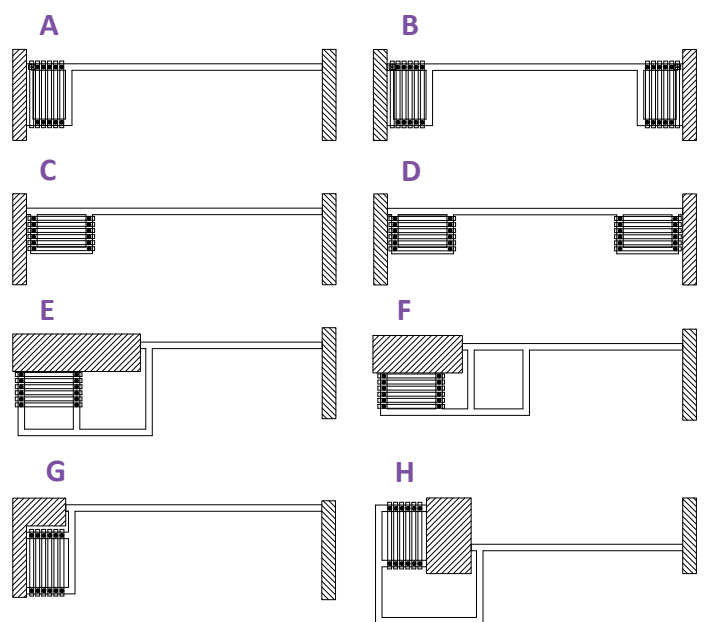

MULTIPLE CHOICES DEPENDING ON YOUR NEEDS



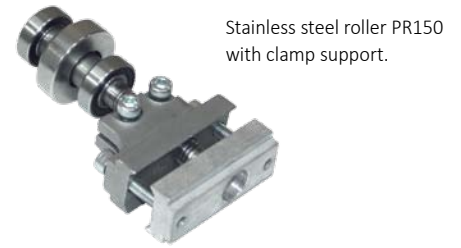
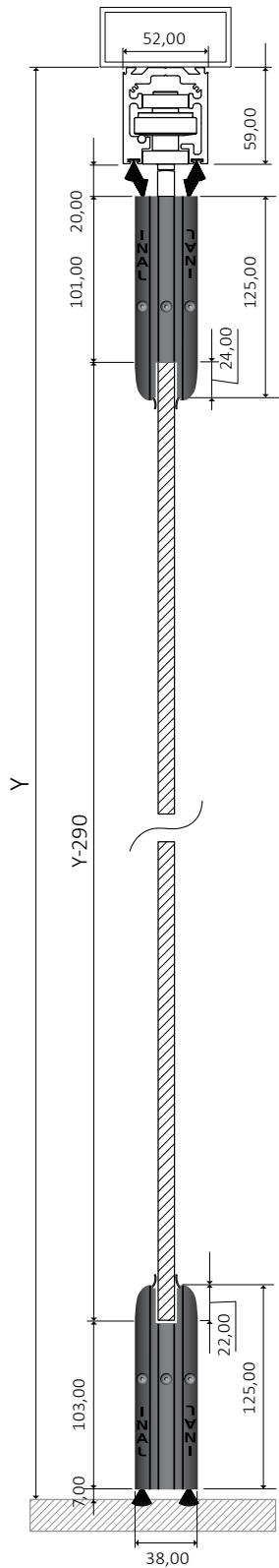

## locking options

### FRONT LOCKING



### SIDE LOCKING



#### GLASS (TEMPERED) DIMENSION CALCULATION

Glass height (mm) =  $Y - 290$ mm, ( Y = from the bottom of the steel beam)

Opening width (mm) = O.W.      Number of panels (pcs) = P.N.

Glass width (mm) =  $\{O.W. - [(P.N. \times 3mm) + 25mm]\} / P.N.$

#### GLASS (LAMINATED) DIMENSION CALCULATION

Glass height (mm) =  $Y - 283$ mm, ( Y = from the bottom of the steel beam)

Opening width (mm) = O.W.      Number of panels (pcs) = P.N.

Glass width (mm) =  $\{O.W. - [(P.N. \times 3mm) + 25mm]\} / P.N.$

# PR-125

## flexible glass door with parking

### PARKING SYSTEM



INAL® Frameless Movable Glass System, parking-type, with upper 70 mm and lower 125 mm aluminum profile. Aluminum middle size rail, 52 mm x 59 mm with **embedded stainless steel rod & stainless steel rollers**. Unlimited design possibilities for parking areas (vertical, diagonal or parallel parkings). Ability to create swing door panel with overhead concealed door closer in intermediate sections of openings (PR150/ SOC). Weather proofing along the entire length of the panel (PR-F125). Locking with Stainless steel front or side bolts or locking with double locking lock mechanism. Available in Do It Yourself (DIY) or Made to measure upon request.

## technical specifications

Glass Type	Tempered or Laminated
Glass thickness	10mm
Panel weight	max 80kg
Maximum panel width	0,95m
Maximum opening height	2,80m
Type of PR-125 System	PR-F125 (Front Locking) PR-S125 (Side Locking)
Finishing	Natural anodized, Satin anodized, RAL powder coating
Without floor guide, No glass cuttings required	

### PANEL STORAGE/PARKING APPLICATIONS

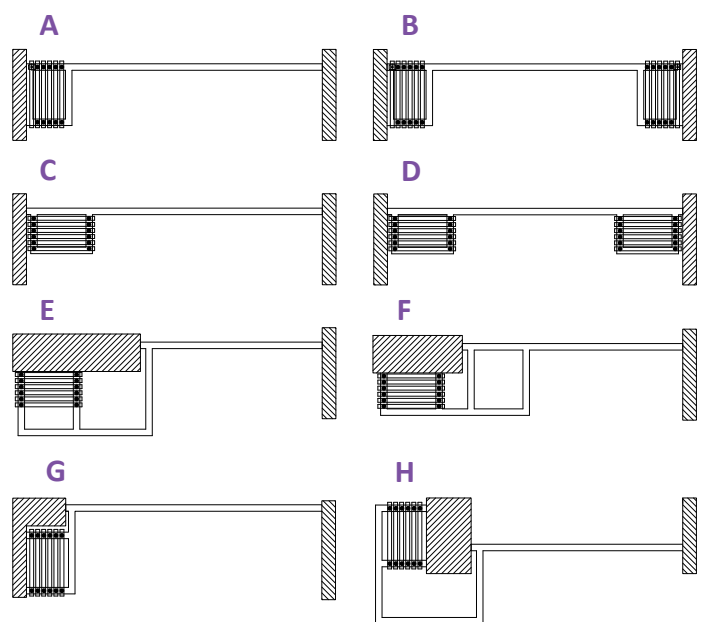

MULTIPLE CHOICES DEPENDING ON  
YOUR NEEDS

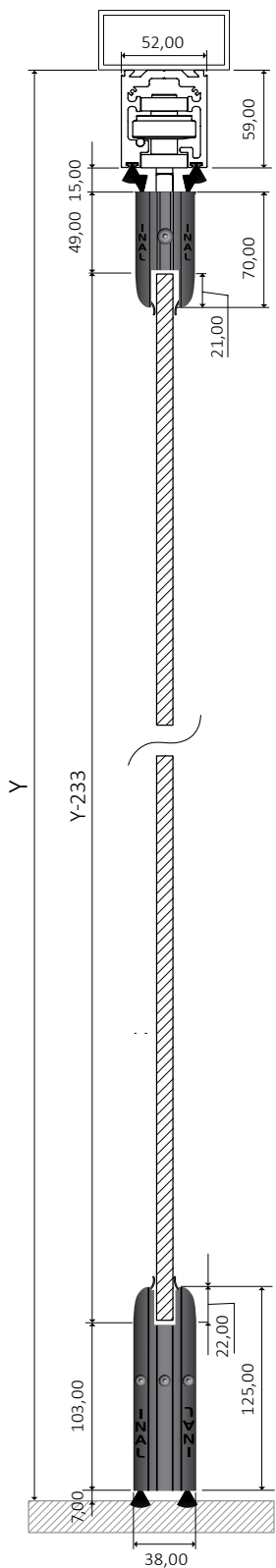

Weather proofing brush between top rail and top profile & between bottom profile and the floor.



Top profile 70mm, bottom profile 125mm



Ability to join two openings in 90° degrees angle, without a vertical column.



NO FLOOR GUIDE  
REQUIRED  
NO GLASS CUTTINGS  
REQUIRED

## locking options

### FRONT LOCKING



Lock Mechanism  
with Eurocylinder  
Key



Lock Mechanism with  
Half Cylinder and knob



Stainless Bolt

### SIDE LOCKING



Side Cap with  
Stainless Bolt



Female Side  
Cap PR-S200

### GLASS (TEMPERED OR LAMINATED) DIMENSION CALCULATION

Glass height (mm) =  $Y - 233\text{mm}$ , (Y = from the bottom of the steel beam)

Opening width (mm) = O.W.      Number of panels (pcs) = P.N.

Glass width (mm) =  $\{O.W. - [(P.N. \times 3\text{mm}) + 25\text{mm}]\} / P.N.$

# PR-100

## mini flexible glass door with parking



INAL® Frameless Movable Glass System, parking-type, with middle size aluminum rail, 52 mm x 59 mm with **embedded stainless steel rod & stainless steel rollers**. Unlimited design possibilities for parking areas (vertical, diagonal or parallel parkings). Ability to create swing door panel with overhead concealed door closer in intermediate sections of openings (PR150/ SOC). Weather proofing along the entire length of the panel (PR-F100). Locking with Stainless steel front bolts or optional plastic front bolts. Available in Do It Yourself (DIY) or Made to measure upon request.

## technical specifications

Glass Type	Tempered or Laminated
Glass thickness	10mm
Panel weight	max 80kg
Maximum panel width	0,95m
Maximum opening height	2,80m
Type of PR-100 System	PR-F100 (Front Locking)
Finishing	Natural anodized, Satin anodized, RAL powder coating
Without floor guide, No glass cuttings required	

## PANEL STORAGE/PARKING APPLICATIONS

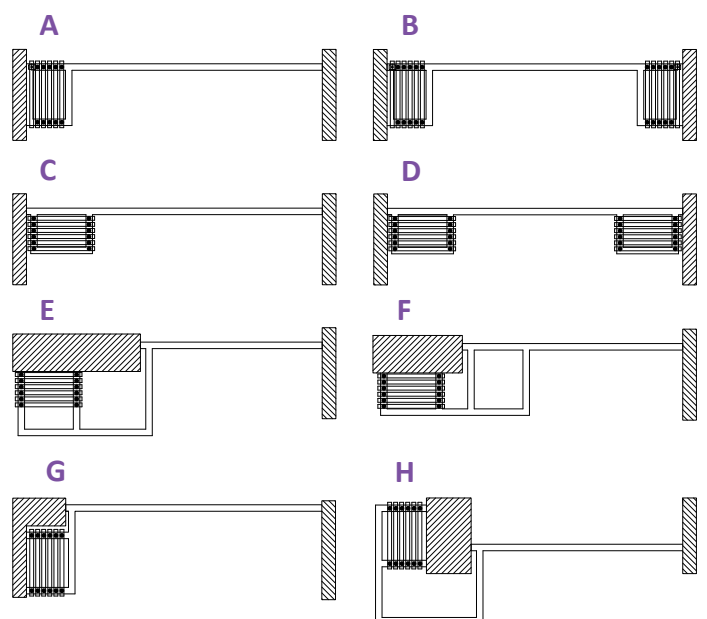

MULTIPLE CHOICES DEPENDING ON YOUR NEEDS

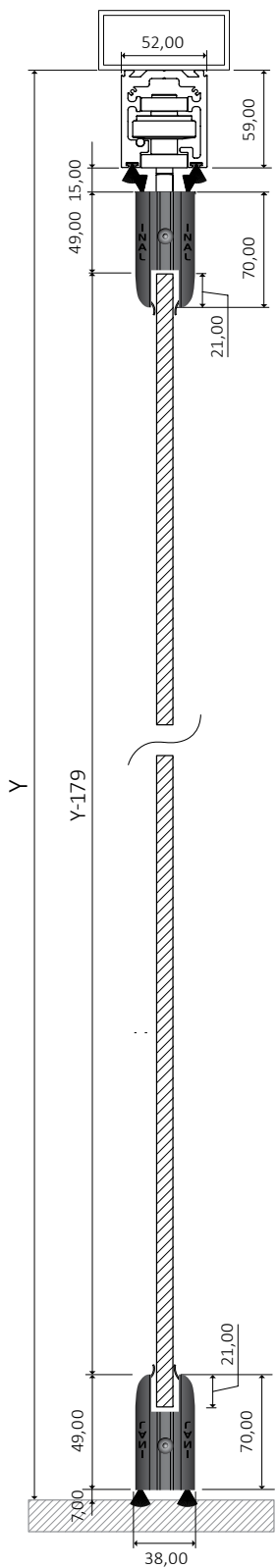

NO GLASS CUTTINGS REQUIRED

## locking options

### FRONT LOCKING



Locking is achieved with the use of stainless bolt at the internal side of each panel.



Optional plastic bolt



Swing door with floor spring upon request.  
Extra additional lock upon request.

### GLASS (TEMPERED OR LAMINATED) DIMENSION CALCULATION

Glass height (mm) =  $Y - 179\text{mm}$ , (Y = from the bottom of the steel beam)

Opening width (mm) = O.W.      Number of panels (pcs) = P.N.

Glass width (mm) =  $\{O.W. - [(P.N. \times 3\text{mm}) + 26\text{mm}]\} / P.N.$

# PR86/R76

## flexible glass door with parking

### PARKING SYSTEM



INAL® Frameless Movable Glass System, parking-type, with heavy duty certified aluminum rail 55mm x 76mm with **embedded stainless steel rod & certified stainless steel rollers**. Weather proofing along the entire length of the panel.

A minimal solution for a movable facade for café, restaurants, shops, hotels e.t.c., with easily self guided storage of the flexible glass panels. Locking with Stainless steel front or side bolts or locking with double locking lock mechanism.

Available in Do It Yourself (DIY) or Made to measure upon request.

## technical specifications

Glass Type	Tempered
Glass thickness	10mm
Panel weight	max 90kg
Maximum panel width	1,00m
Maximum opening height	3,00m
Type of PR86/R76 System	PRS86/R76 (Side Locking)
Finishing	Natural anodized, Satin anodized, Ral powder coating
Without floor guide, No glass cuttings required	

### PANEL STORAGE/PARKING AREA

EASILY SELF GUIDED STORAGE OF THE FLEXIBLE GLASS PANELS

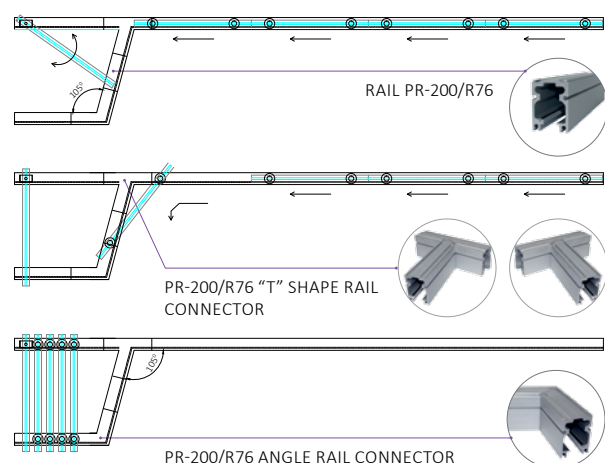

### PARKING APPLICATIONS

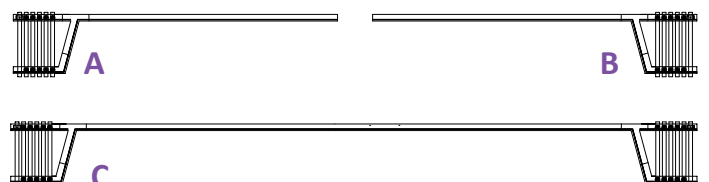

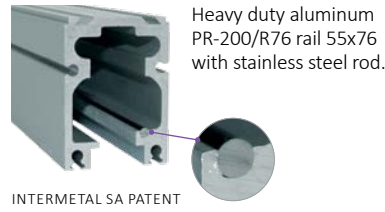
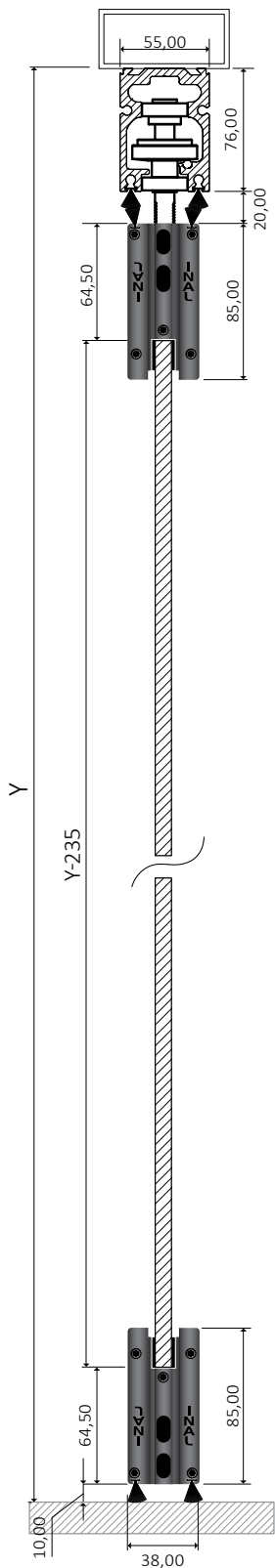

Stainless steel roller for diversion movement, with clamp support.



Stainless steel roller for straight movement, with clamp support.



A minimal solution for a movable facade



Available in Do It Yourself (DIY) kit boxes.



**NO FLOOR GUIDE  
REQUIRED**

**NO GLASS CUTTINGS  
REQUIRED**

## locking options

### FRONT LOCKING



Lock Mechanism with Eurocylinder Key 54mm



Lock Mechanism with Half Cylinder with knob



Stainless steel Bolt

### SIDE LOCKING



Side Cap with Stainless Bolt PR-86 Steel



Female Side Cap PR-86

### GLASS (TEMPERED) DIMENSION CALCULATION

Glass height (mm) =  $Y - 235\text{mm}$ , (Y = from the bottom of the steel beam)

Opening width (mm) = O.W.      Number of panels (pcs) = P.N.

Glass width (mm) =  $\{O.W. - [(P.N. \times 4\text{mm}) + 27\text{mm}]\} / P.N.$

# FRP-75

## movable glass door with frame & parking

### PARKING SYSTEM



INAL® Framed Parking System FRP-75 with heavy duty certified aluminum rail 70 mm x 80 mm with **embedded stainless steel rod & certified stainless steel rollers**. Special designed aluminum profiles create a strong frame for a variety of glass such as tempered up to 12mm, laminated up to 6+6, double glazing with a total thickness of up to 18mm. High resistance female & male vertical profiles for the maximum weather proofing between framed panels in combination with adjustable side aluminum case profiles. Ability to create swing door panel with overhead concealed door closer in intermediate sections of openings (FRP75/SOC). Locking with eurocylinder or front bolts.

## technical specifications

Glass Type	Double glazing Tempered or Laminated
Glass thickness	max 18mm
Panel weight	max 100kg
Maximum panel width	1,00m
Maximum opening height	3,00m
Type of FRP-75 System	Front Locking
Finishing	Natural anodized, Satin anodized, RAL powder coating
Without floor guide, No glass cuttings required	

### PANEL STORAGE/PARKING APPLICATIONS

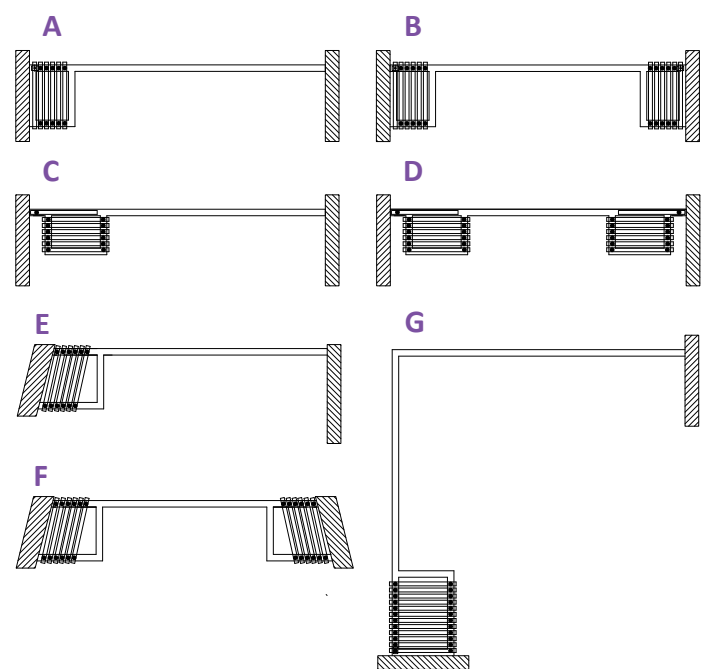

MULTIPLE CHOICES DEPENDING ON YOUR NEEDS



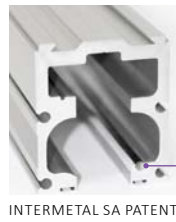
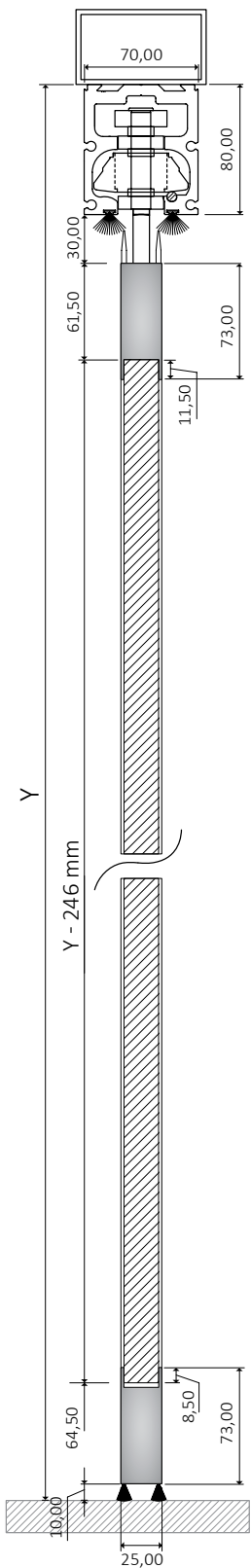

Heavy duty aluminum rail 70x80 with embedded stainless steel rod  
**STRENGTH TEST:** 3.450kg (165/049.01-1 N.T.U.A.).

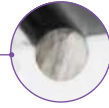

INTERMETAL SA PATENT



Stainless steel roller PR200 with frame support.  
**STRENGTH TEST:** 4.600kg (165/049.01-2 N.T.U.A.).



High resistance female & male vertical profiles for the maximum weather proofing between framed panels.

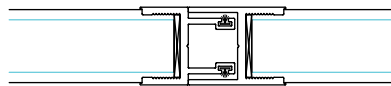

Stainless steel handle to the swing panel. upon request.



**NO FLOOR GUIDE REQUIRED**  
**NO GLASS CUTTINGS REQUIRED**

## locking options

### FRONT LOCKING



Lock mechanism with eurocylinder



Internal locking bolt.



With additional lock to the vertical profile.

**GLASS (TEMPERED OR LAMINATED OR DOUBLE GLAZING) DIMENSION CALCULATION**

Glass height (mm) =  $Y - 246$ mm, (Y = from the bottom of the steel beam)

# FRP-75/R76

## movable glass door with frame & parking

### PARKING SYSTEM



INAL® Framed Parking System FRP-75/R76 with heavy duty certified aluminum rail 55 mm x 76 mm with **embedded stainless steel rod & certified stainless steel rollers**. Special designed aluminum profiles create a strong frame for a variety of glass such as tempered up to 12mm, laminated up to 6+6, double glazing with a total thickness of up to 18mm. High resistance female & male vertical profiles for the maximum weather proofing between framed panels in combination with adjustable side aluminum case profiles. Ability to create swing door panel with overhead concealed door closer in intermediate sections of openings (FRP75/R76 SOC). Locking with eurocylinder or front bolts.

## technical specifications

Glass Type	Double glazing Tempered or Laminated
Glass thickness	max 18mm
Panel weight	max 100kg
Maximum panel width	1,00m
Maximum opening height	3,00m
Type of FRP-75/R76 System	Front Locking
Finishing	Natural anodized, Satin anodized, RAL powder coating
Without floor guide, No glass cuttings required	

### PANEL STORAGE/PARKING AREA

EASILY SELF GUIDED STORAGE OF THE FLEXIBLE GLASS PANELS

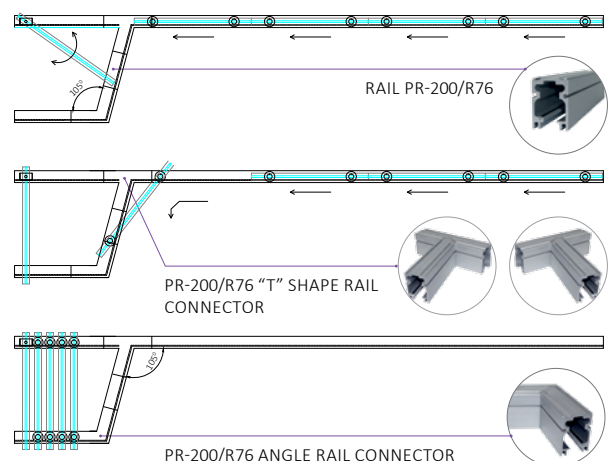

### PARKING APPLICATIONS

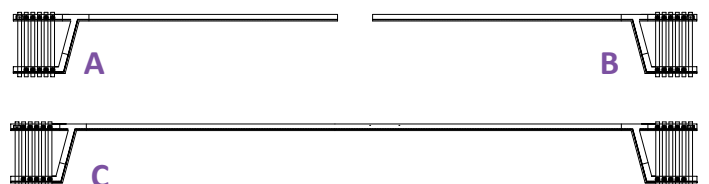

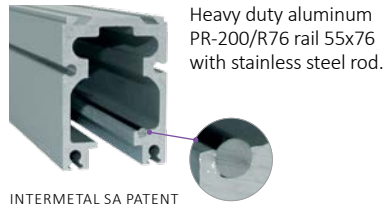
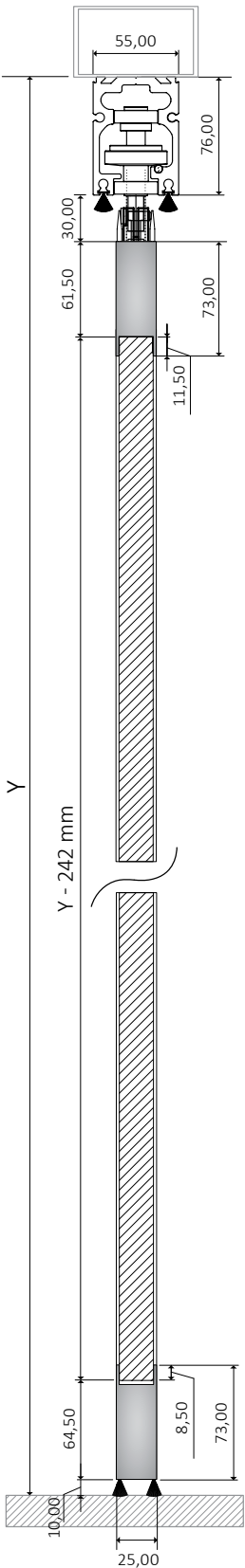

Stainless steel roller for diversion movement, with frame support.

Stainless steel roller for straight movement, with frame support.



High resistance female & male vertical profiles for the maximum weather proofing between framed panels.

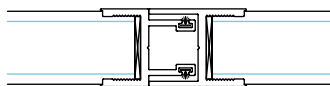

Handle to the swing panel, upon request.



NO FLOOR GUIDE REQUIRED

NO GLASS CUTTINGS REQUIRED

## locking options

### FRONT LOCKING



Lock mechanism with eurocylinder



Internal locking bolt.



With additional lock to the vertical profile.

GLASS (TEMPERED OR LAMINATED OR DOUBLE GLAZING) DIMENSION CALCULATION

Glass height (mm) =  $Y - 242$ mm, (Y = from the bottom of the steel beam)

# FRP-75/R60

## movable glass door with frame & parking

### PARKING SYSTEM



INAL® Framed Parking System FRP-75/R60 with middle size aluminum rail, 52 mm x 59 mm with **embedded stainless steel rod & stainless steel rollers**. Special designed aluminum profiles create a strong frame for a variety of glass such as tempered up to 12mm, laminated up to 6+6, double glazing with a total thickness of up to 18mm. High resistance female & male vertical profiles for the maximum weather proofing between framed panels in combination with adjustable side aluminum case profiles. Ability to create swing door panel with overhead concealed door closer in intermediate sections of openings (FRP75/R60 SOC). Locking with eurocylinder or front bolts.

## technical specifications

Glass Type	Double glazing Tempered or Laminated
Glass thickness	max 18mm
Panel weight	max 75kg
Maximum panel width	0,90m
Maximum opening height	2,80m
Type of FRP-75/R60 System	Front Locking
Finishing	Natural anodized, Satin anodized, RAL powder coating
Without floor guide, No glass cuttings required	

### PANEL STORAGE/PARKING APPLICATIONS

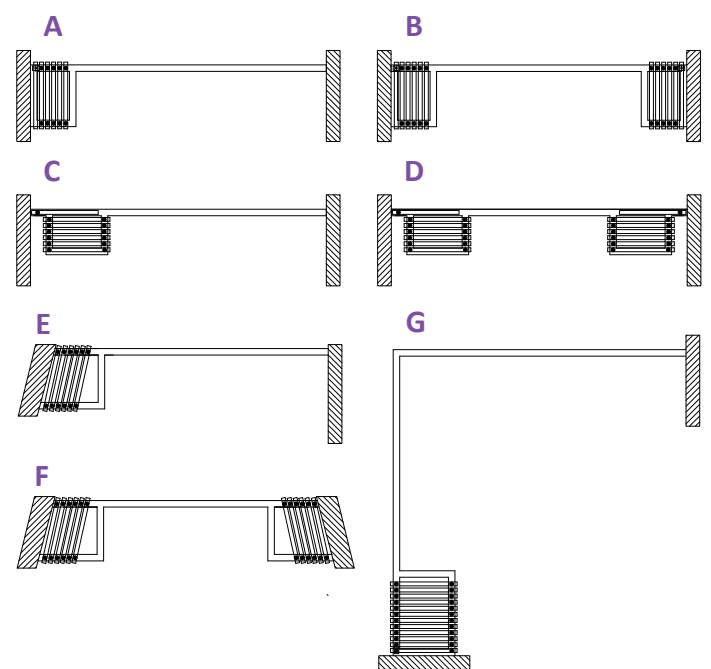

MULTIPLE CHOICES DEPENDING ON YOUR NEEDS

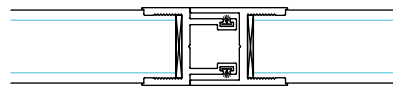
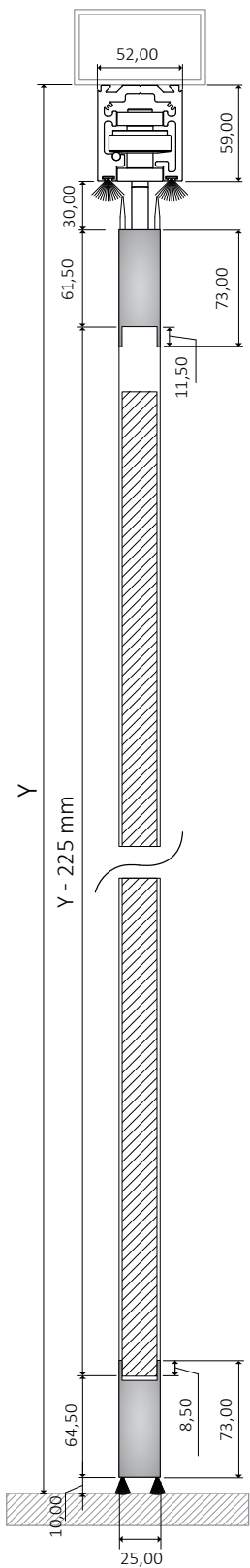

NO FLOOR GUIDE  
REQUIRED

NO GLASS CUTTINGS  
REQUIRED

## locking options

### FRONT LOCKING



Lock  
mechanism  
with  
eurocylinder



Internal  
locking bolt.



With additional lock to  
the vertical profile.

**GLASS (TEMPERED OR LAMINATED OR DOUBLE GLAZING) DIMENSION CALCULATION**

Glass height (mm) =  $Y - 225\text{mm}$ , (Y = from the bottom of the steel beam)

# FN-200

## folding glass door with heavy duty rail

### FOLDING SYSTEM



INAL® Frameless Folding door System, heavy type, with heavy duty certified aluminum rail 70 mm x 80 mm with embedded stainless steel rod & certified stainless steel rollers.

INAL Folding System FN-200 use a heavy duty aluminum hinge at the upper and lower profile. The special design and high quality of hinges ensure functionality, durability and lifetime operation.

Weather proofing with polycarbonate or PVC profiles between the panels. Locking with Stainless steel front or side bolts or locking with double locking lock mechanism.

Available in Do It Yourself (DIY) or Made to measure upon request.

## technical specifications

Glass Type	Tempered or Laminated
Glass thickness	10- 12mm
Panel weight	max 90kg
Maximum panel width	1,00m
Maximum opening height	3,50m
Type of FN-200 System	Front Locking
Finishing	Natural anodized, Satin anodized, RAL powder coating
Without floor guide, No glass cuttings required	

### PANEL STORAGE/FOLDING APPLICATIONS

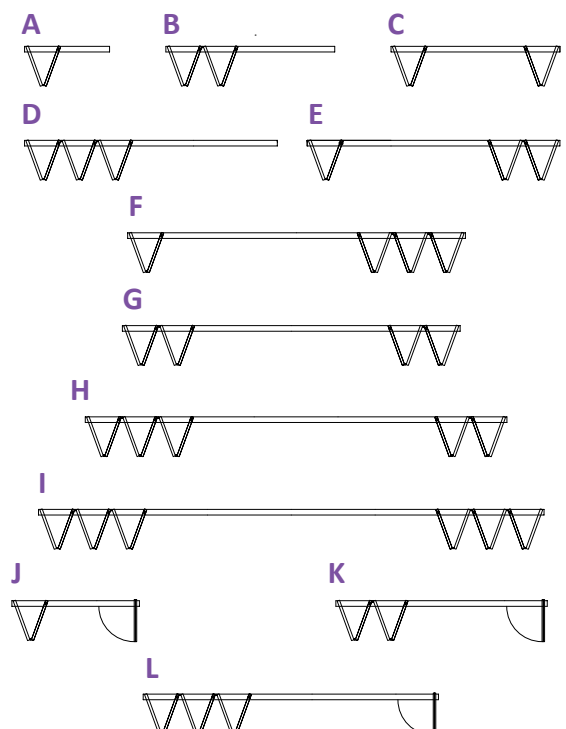

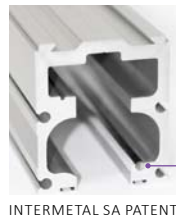
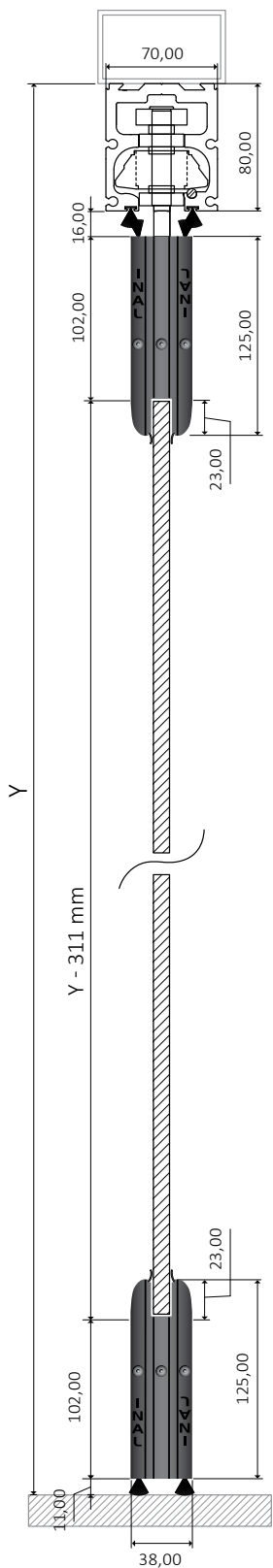

Heavy duty aluminum rail 70x80 with embedded stainless steel rod  
**STRENGTH TEST:** 3.450kgr (165/049.01-1 N.T.U.A.).



Stainless steel roller PR200 with clamp support.  
**STRENGTH TEST:** 4.600kgr (165/049.01-2 N.T.U.A.).



Heavy duty hinges between the panels.



**NO FLOOR GUIDE REQUIRED**

**NO GLASS CUTTINGS REQUIRED**



Durability and lifetime operation

## locking options

### FRONT LOCKING



Lock Mechanism with eurocylinder Key



Lock Mechanism with Half Cylinder and knob



Stainless Bolt

#### GLASS (TEMPERED) DIMENSION CALCULATION

Glass height (mm) =  $Y - 311\text{mm}$ , ( Y = from the bottom of the steel beam)

Opening width (mm) = O.W.      Number of panels (pcs) = P.N.

Glass width (mm) =  $\{O.W. - [(P.N. \times 3\text{mm}) + 20\text{mm}]\} / P.N.$

#### GLASS (LAMINATED) DIMENSION CALCULATION

Glass height (mm) =  $Y - 295\text{mm}$ , ( Y = from the bottom of the steel beam)

Opening width (mm) = O.W.      Number of panels (pcs) = P.N.

Glass width (mm) =  $\{O.W. - [(P.N. \times 3\text{mm}) + 20\text{mm}]\} / P.N.$

# FN-150

## folding glass door



INAL® Frameless Folding door System, with middle size aluminum rail, 52 mm x 59 mm with embedded stainless steel rod & certified stainless steel rollers.

INAL Folding System FN-150 use a heavy duty aluminum hinge at the upper and lower profile. The special design and high quality of hinges ensure functionality, durability and lifetime operation.

Weather proofing with polycarbonate profiles between the panels. Locking with Stainless steel front bolts in a wide range, also locking with double locking lock mechanism.

Available in Do It Yourself (DIY) or Made to measure upon request.

## technical specifications

Glass Type	Tempered or Laminated
Glass thickness	10mm
Panel weight	max 85kg
Maximum panel width	1,00m
Maximum opening height	2,80m
Type of FN-150 System	Front Locking
Finishing	Natural anodized, Satin anodized, RAL powder coating
Without floor guide, No glass cuttings required	

## PANEL STORAGE/FOLDING APPLICATIONS

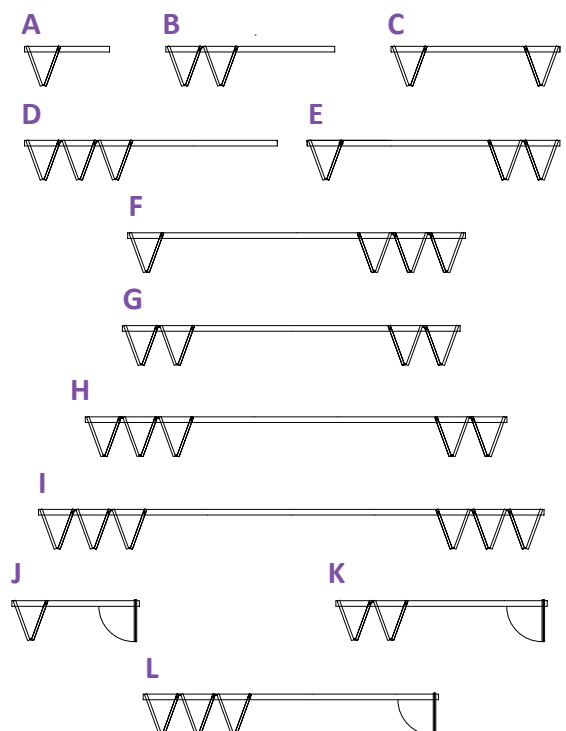



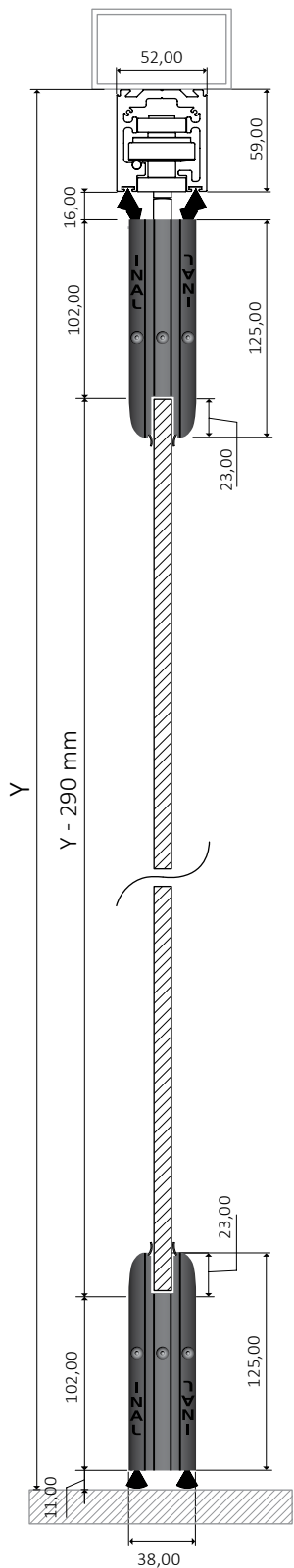

Aluminum middle size rail  
52x59 with embedded  
stainless steel rod.



INTERMETAL SA PATENT



Stainless steel roller PR150 with  
clamp support.



Heavy duty aluminum hinge at the upper  
and lower profile.



NO FLOOR GUIDE  
REQUIRED

NO GLASS CUTTINGS  
REQUIRED

Weather proofing brush between bottom  
profile and the floor.



Storage of folding panels.

## locking options

### FRONT LOCKING



Lock Mechanism with  
eurocylinder Key



Lock Mechanism with  
Half Cylinder and knob



Stainless Bolt

#### GLASS (TEMPERED) DIMENSION CALCULATION

Glass height (mm) =  $Y - 290\text{mm}$ , ( Y = from the bottom of the steel beam)

Opening width (mm) = O.W.      Number of panels (pcs) = P.N.

Glass width (mm) =  $\{O.W. - [(P.N. \times 3\text{mm}) + 20\text{mm}]\} / P.N.$

#### GLASS (LAMINATED) DIMENSION CALCULATION

Glass height (mm) =  $Y - 274\text{mm}$ , ( Y = from the bottom of the steel beam)

Opening width (mm) = O.W.      Number of panels (pcs) = P.N.

Glass width (mm) =  $\{O.W. - [(P.N. \times 3\text{mm}) + 20\text{mm}]\} / P.N.$

# FN-100

## folding glass door

### FOLDING SYSTEM



INAL® Frameless Folding door System, with upper and lower aluminum profile 70 mm. Aluminum middle size rail 52 mm x 59 mm with embedded stainless steel rod & stainless steel rollers.

INAL® Folding System FN-100 use aluminum hinge at the upper and lower profile. The special design and high quality of hinges ensure functionality, durability and lifetime operation. Weather proofing along the entire length of the panel.

Locking with Stainless steel front bolts in the bottom hinges.

Available in Do It Yourself (DIY) or Made to measure upon request.

## technical specifications

Glass Type	Tempered or Laminated
Glass thickness	10 mm
Panel weight	max 55kg
Maximum panel width	0,80m
Maximum opening height	2,70m
Type of FN-100 System	Front Locking
Finishing	Natural anodized, Satin anodized, RAL powder coating
Without floor guide, No glass cuttings required	

### PANEL STORAGE/FOLDING APPLICATIONS

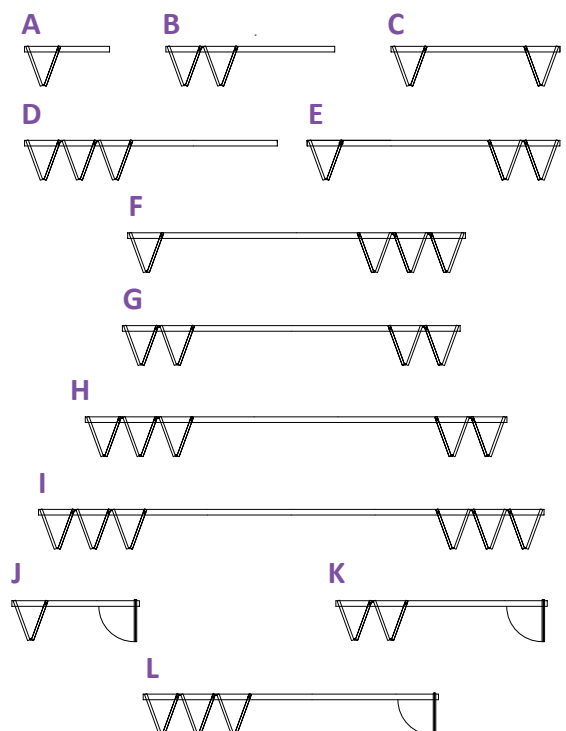

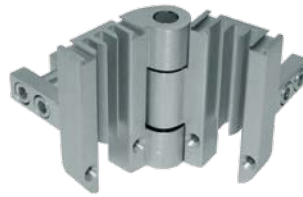
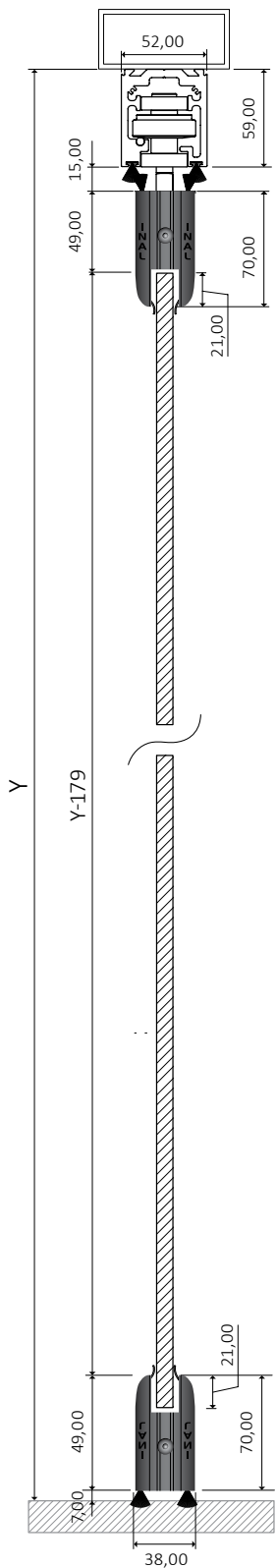

NO GLASS CUTTINGS REQUIRED

## locking options

### FRONT LOCKING



#### GLASS (TEMPERED & LAMINATED) DIMENSION CALCULATION

Glass height (mm) =  $Y - 179\text{mm}$ , (Y = from the bottom of the steel beam)

Opening width (mm) = O.W.      Number of panels (pcs) = P.N.

Glass width (mm) =  $\{O.W. - [(P.N. \times 3\text{mm}) + 24\text{mm}]\} / P.N.$

# FN-M200

## folding glass door with heavy duty rail

### FOLDING SYSTEM



INAL® Frameless Folding door System, heavy type, with heavy duty certified aluminum rail 70 mm x 80 mm with embedded stainless steel rod & certified stainless steel rollers.

INAL Folding System FN-M200 use a heavy duty aluminum hinge at the upper and lower profile. The special design and high quality of hinges ensure functionality, durability and lifetime operation. Weather proofing with polycarbonate or PVC profiles between the panels. Locking with Stainless steel front or side bolts or locking with double locking lock mechanism.

Available in Do It Yourself (DIY) or Made to measure upon request.

## technical specifications

Glass Type	Tempered or Laminated
Glass thickness	10- 12mm
Panel weight	max 90kg
Maximum panel width	1,00m
Maximum opening height	3,50m
Type of FN-M200 System	Front Locking
Finishing	Natural anodized, Satin anodized, RAL powder coating
Without floor guide, No glass cuttings required	

### PANEL STORAGE/FOLDING APPLICATIONS

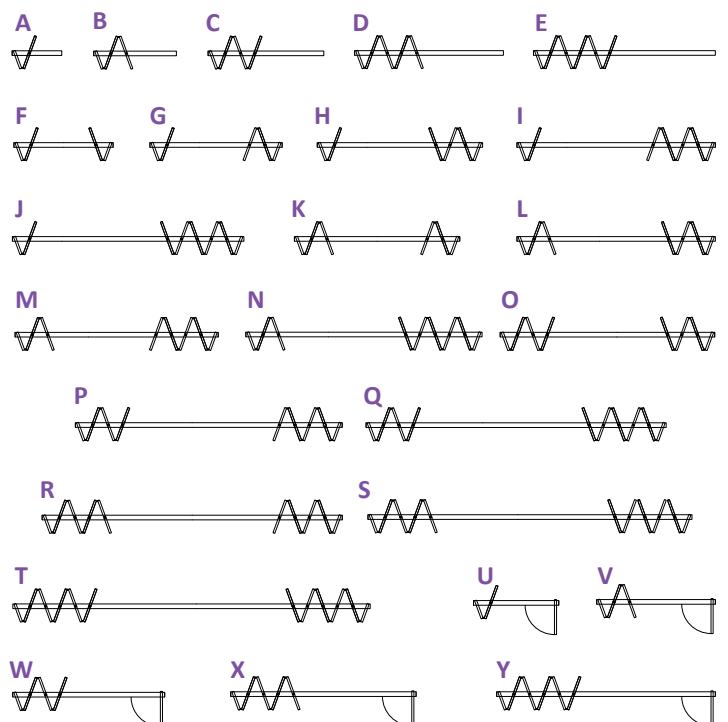

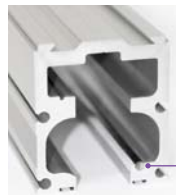
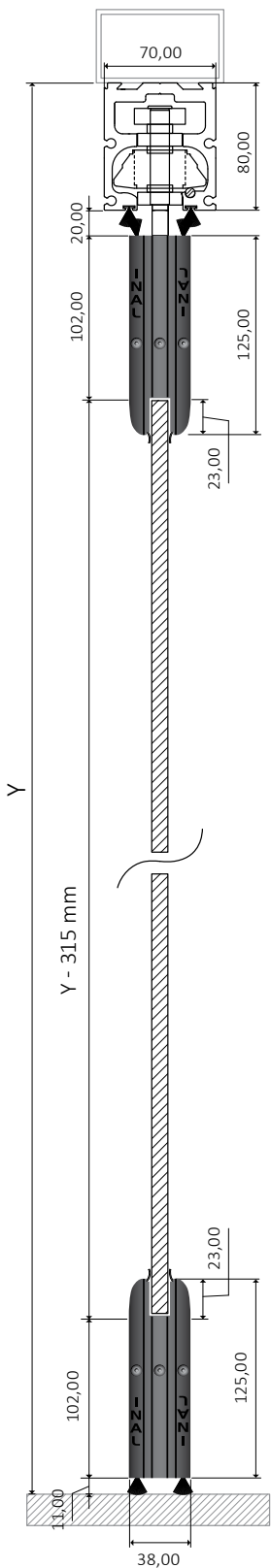

Heavy duty aluminum rail 70x80 with embedded stainless steel rod  
**STRENGTH TEST:** 3.450kg (165/049.01-1 N.T.U.A.).

INTERMETAL SA PATENT

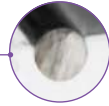

Stainless steel roller PR200 with clamp support. **STRENGTH TEST:** 4.600kg (165/049.01-2 N.T.U.A.).



Heavy duty hinges between the panels.



Durability and lifetime operation

\* Middle folding option is also available in FN-M150 and FN-M100 models

## locking options

### FRONT LOCKING



Lock Mechanism with eurocylinder Key



Lock Mechanism with Half Cylinder and knob



Stainless Bolt



NO FLOOR GUIDE REQUIRED

NO GLASS CUTTINGS REQUIRED

#### GLASS (TEMPERED) DIMENSION CALCULATION

Glass height (mm) =  $Y - 315\text{mm}$ , ( Y = from the bottom of the steel beam)

Opening width (mm) = O.W.      Number of panels (without the half panel)(pcs) = P.N.

1st (half panel) glass width (mm) = G.W. 1      Glass width (rest panels) (mm) = G.W. N

$G.W.N. = \{O.W. - [(P.N. + 1) \times 3\text{mm}] + 83\text{mm}\} : (P.N. + 0,5)$

$G.W. 1 = (G.W.N. : 2) + 51\text{mm}$

#### GLASS (LAMINATED) DIMENSION CALCULATION

Glass height (mm) =  $Y - 300\text{mm}$ , ( Y = from the bottom of the steel beam)

Opening width (mm) = O.W.      Number of panels (without the half panel)(pcs) = P.N.

1st (half panel) glass width (mm) = G.W. 1      Glass width (rest panels) (mm) = G.W. N

$G.W.N. = \{O.W. - [(P.N. + 1) \times 3\text{mm}] + 83\text{mm}\} : (P.N. + 0,5)$

$G.W. 1 = (G.W.N. : 2) + 51\text{mm}$

# PANORAMA

## folding glass door

### FOLDING SYSTEM



INAL® Folding door System with heavy duty certified aluminum top rail 70 mm x 80 mm with embedded stainless steel rod & certified stainless steel rollers and floor guide.

PANORAMA Folding System is suitable for internal spaces with the use of special design aluminum upper and lower hinges, without profiles. Weather proofing with polycarbonate or PVC profiles between the panels. Locking with Stainless steel front bolt in the bottom hinges.

Available in Do It Yourself (DIY) or Made to measure upon request.

## technical specifications

Glass Type	Tempered
Glass thickness	8- 10 - 12mm
Panel weight	max 70kg
Maximum panel width	1,00m
Maximum opening height	2,70m
Type of PANORAMA System	Front Locking
Type of locking	Stainless bolt
Finishing	Natural anodized, Satin anodized, RAL Powder coating
<b>With floor guide, Glass cuttings required</b>	

### PANEL STORAGE/FOLDING APPLICATIONS

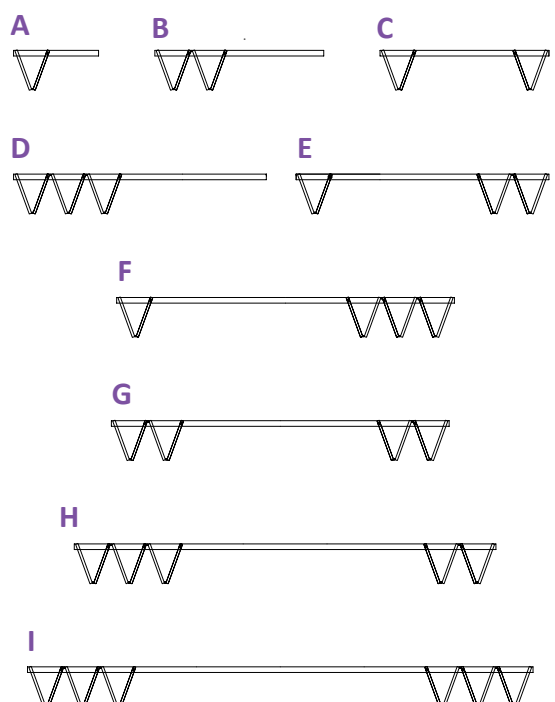

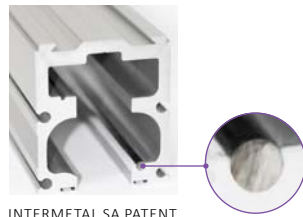
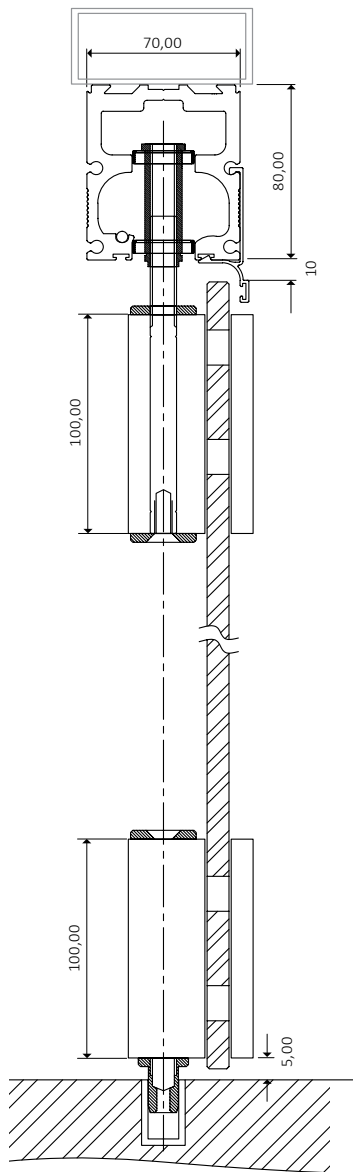

INTERMETAL SA PATENT

Heavy duty aluminum rail 70x80 with embedded stainless steel rod  
**STRENGTH TEST:**  
 3.450kg  
 (165/049.01-1 N.T.U.A.).

## system hinges



Upper single hinge with roller  
 CODE **501MR**



Upper double hinge with roller  
 CODE **501DR**



Upper double hinge  
 CODE **501D**



Lower double hinge with pin  
 CODE **502DP**



Lower double hinge with bolt  
 CODE **502DS**



Lower single hinge with pin  
 CODE **502MP**

**With floor guide**  
**Glass cuttings required**

## floor guide

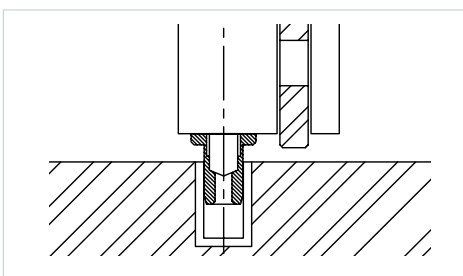

## upper view

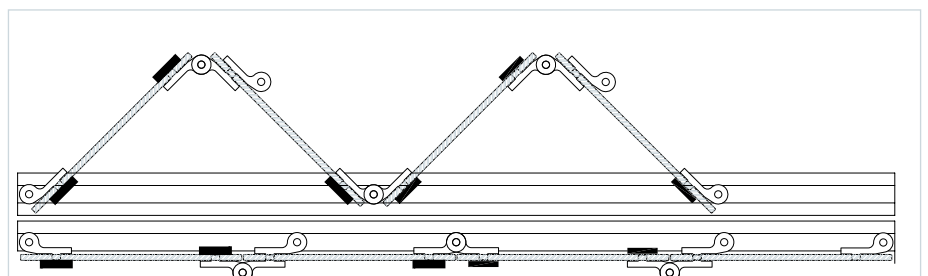

# FLEXIBLE GLASS DOORS



## ALSO DOWNLOAD OUR PRODUCT CATALOGUES

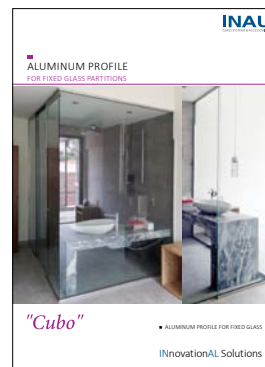
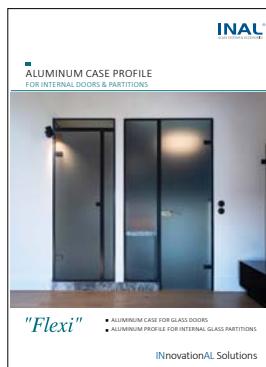

# INnovationAL Solutions